

INSTRUCTION MANUAL

Product code: 10010102

STEP 1:

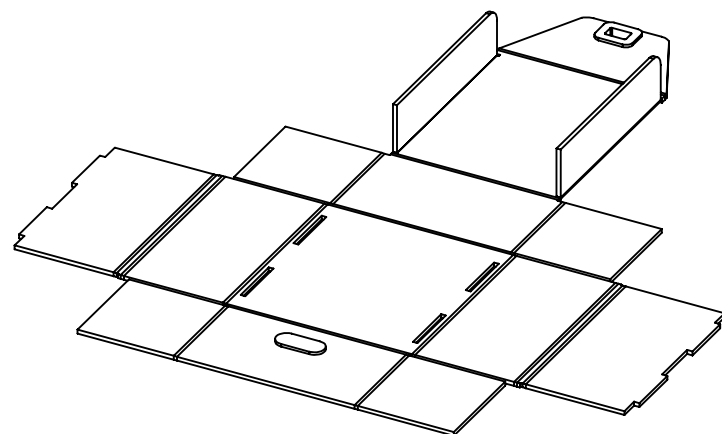

STEP 2:

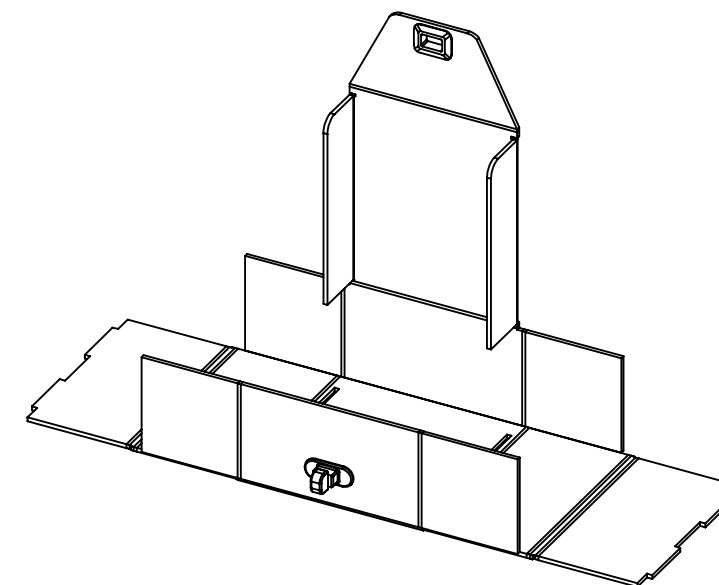

STEP 3:

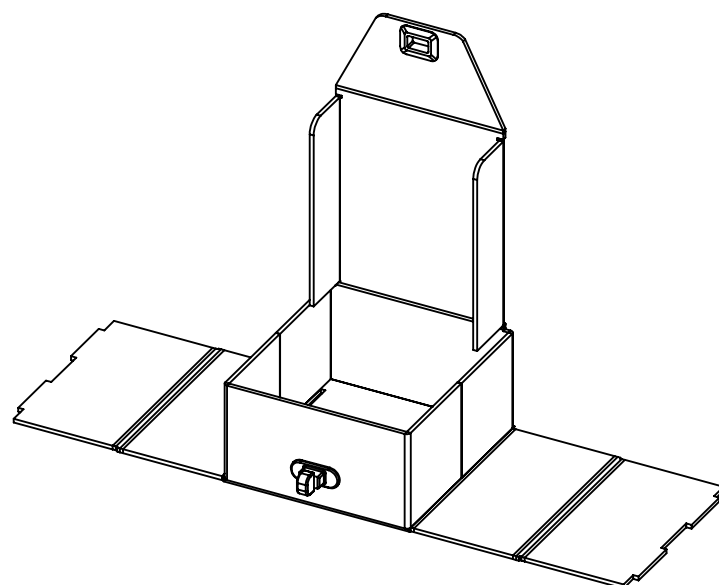

STEP 4:

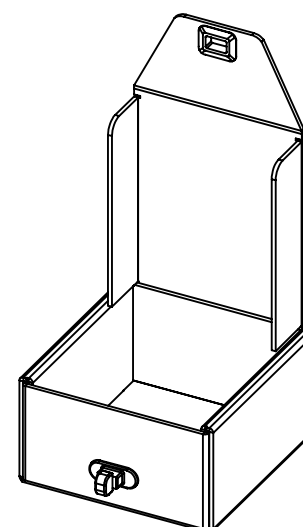

STEP 5:

